

Magnum Mobile Lite Generator – MLG8 Specifications

ENGINE

- Mitsubishi® L3E-W461ML - naturally aspirated, diesel engine
 - Prime - 10.5 hp @ 1800 rpm
 - 3 cylinder
 - 1.0 L displacement
 - Interim Tier IV approved
- Polyethylene fuel tank
 - 30 gal. capacity
 - 48 hr. run time – full load
 - 3 ½" fill port
- Fuel consumption at prime:
 - 100% - 0.63 gph (2.38 Lph)
 - 75% - 0.47 gph (1.78 Lph)
 - 50% - 0.32 gph (1.21 Lph)
- Cooling system capable of operating at 120°F ambient
- Rubber vibration dampers isolate engine/generator from frame
- Full flow oil filter, spin on type
- Fuel filter with replaceable element
- Dry type cartridge air filter
- 60 Hz engine/generator

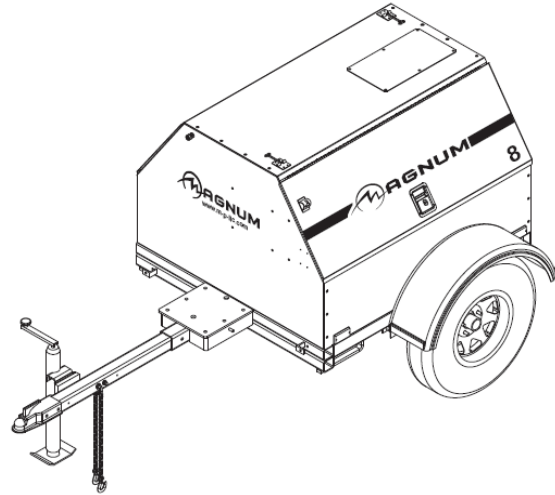

ENGINE CONTROLS

- Engraved aluminum punched and anodized control panel
- Four position keyed switch – glow plugs (preheat, off, run, start)
- Hour meter
- Automatic low oil/high temperature shutdown system

GENERATOR

- Marathon Electric®
 - Brushless
 - 4 pole
 - Class H insulation
- Single phase output
 - Prime - 6 kW / 6 kVA (25A @ 240V)
 - Standby - 7.3 kW / 7.3 kVA (30A @ 240V)
- Voltage regulation +/- 1% with Marathon SE350 Voltage Regulator

ELECTRICAL SYSTEM AND CONTROLS

- 40A start limit breaker (assures no load condition exists before starting)
- Convenience receptacles with individual breakers
 - (2) 120V 20 Amp GFCI duplex outlets (Nema 5-20R type)
 - (1) 240V 30 Amp twistlock outlets (Nema L6-30R type)
- 440 CCA wet cell battery

ENCLOSURE

- Steel, 14-gauge, sound attenuated enclosure
 - UV & fade resistant, high temperature cured, white polyester powder paint
 - Insulated and baffled
 - 70 dB(A) at 23 feet – prime power
- Fully lockable enclosure
- Stainless steel hinges, door latches and exterior hardware
- Emergency stop switch located on front panel
- License plate holder with light
- Multi-lingual operating/safety decals
- Document holder with operating/parts manuals including AC/DC wiring diagrams

TRAILER

- DOT approved tail, side, brake, and directional lights
 - Recessed rear lights
- Transportation tie downs
- Safety chains with spring loaded safety hooks
- Single wall polyethylene fenders
- 2" ball hitch
- 2200 lb. leaf spring axle
- 2000 lb. tongue jack with footplate
- ST175/80D13 tubeless tires – 6 ply
- 48" track width

WEIGHTS & DIMENSIONS

- Dry weight: 1030 lbs (467 kg)
- Operating weight: 1250 lbs (567 kg)
- 105 x 67 x 56 in
(2.67 x 1.70 x 1.42 m)

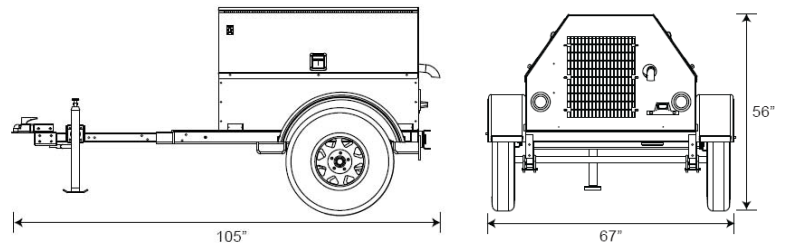

WARRANTY

- Engine and generator covered under OEM warranty – consult factory for details

CERTIFICATIONS

- CSA certified



MLG8 Options

ENGINE OPTIONS

- ◆ Heated fuel filter
- ◆ Lower radiator hose – engine heater
- ◆ Oil drain valve kit

ELECTRICAL CONTROLS OPTIONS

- ◆ 720 CCA gel cell battery
- ◆ 720 CCA wet cell battery
- ◆ 685 CCA gel cell battery
- ◆ Battery disconnect
- ◆ Battery charger – 2A trickle

VOLTAGE OUTPUT OPTIONS

- ◆ Alternative receptacle panel – consult factory for configurations

COOLANT OPTIONS

- ◆ 60/40 Coolant – cold weather applications

ENCLOSURE OPTIONS

- ◆ Interior cabinet light
- ◆ Level indicator
- ◆ Tamper pack
- ◆ Liquid containment / Quiet pack
- ◆ Lift structure

FUEL TANK OPTIONS

- ◆ 56 gal. fuel tank
- ◆ Tethered fuel tank cap

TRAILER OPTIONS

- ◆ 6 pin or 7 spade electrical connectors
- ◆ Outrigger package
- ◆ Tube and sleeve jack
- ◆ Spare tire/wheel kit

HITCH OPTIONS

- ◆ 2.5” lunette ring
- ◆ 3” lunette ring
- ◆ 3” HD lunette ring
- ◆ 2 5/16” ball
- ◆ Combination hitch – 2.5” lunette ring / 2” ball

